

p+a furniture



CONTRACT
THE GREEN HOTEL ROOM

p+a furniture



table of contents

FACT SHEET	1
CENTRO LINE	2
headboard full/queen	2
headboard king	3
platform base for full/queen mattresses	4
platform base for king mattresses	5
daybed base	6
entertain	7
mini bar	8
dine	9
work I	10
work II	11
storage I	12
storage II	13
storage III	14
bench I	15
bench II	16
bench III	17
SOFT GOODS	18
organic cotton terry towels	18
organic cotton Sateen sheet sets	19
Crescent Moon alpaca + sheep wool pillows	20
WARRANTY	21
PRICING	ON A PER PROJECT BASIS

fact sheet

p+a furniture aspires to set the standard for contract furnishings, with a simple and modern aesthetic and an inherent sustainability. p+a furniture is designed to create beauty in the built environment, incorporating flexible and modular elements that seamlessly integrate into many interiors. p+a furniture builds upon the green innovation by designers at Penner & Associates, a leading sustainable interiors firm in Canada. Following incorporation of p+a furniture in 2007, research and development ensued, with the official opening of p+a's Vancouver showroom in June 2009 and launch of the online store in August 2009. More recently, the company has focused on expanding their signature centro line for hospitality environments.

centro contract + the green hotel room

The award winning centro line is integral to the green hotel room, which is organized into 3 zones — Live, Restore and Cleanse. A play on cantilevered forms, the centro line has been expanded with new elements for in-room work and relaxation, and space-efficient storage, with the purpose of enhancing the hospitality experience, well-being and comfort. The line includes headboards, mattress platforms, daybeds, entertainment units, mini bars, dining tables, desks, storage units and benches.

p+a furniture can also work with facility managers, consultants and design professionals to develop exclusive packages specific to hotel developments and chains. Packages will include elements essential to hospitality accommodation — materials, finishes, furniture, fixtures and equipment — and can extend to common and amenity areas. The design considers refurbishment cycles to renew the aesthetic in a cost-effective and sustainable manner, while meeting the requirements of applicable hotel rating systems.

materials

Manufactured in Calgary and Vancouver, p+a furniture casegoods are designed for sustainability, making efficient use of responsibly-sourced materials. Use of p+a furniture contributes to LEED® credits and points. Contract orders of sizable volume for LEED® projects will be submitted for IAQ testing to meet the requirements of LEED-CI EQ Credit 4.5 Low-Emitting Materials, Furniture and Seating.

p+a furniture casegoods

- are regionally manufactured, if you are within 800 km/500 miles of our manufacturing facilities
- utilize certified veneers and solid wood from sustainably-managed forests
- utilize salvaged solid wood
- contain no added urea formaldehyde in the composite woods and adhesives
- have a high percentage of post-industrial recycled content in the composite woods
- have post-consumer recycled content in the metal components
- utilize water-based, low-VOC stains and finishes
- have a UV-cured top coat on wood veneers for superior durability
- use natural and rapidly renewable materials
- are packaged efficiently with reusable, recycled content and or recyclable materials

Veneer options include Forest Stewardship Council (FSC certified) Eucalyptus, fumed White Oak, White Oak stained dark cacao and Douglas Fir. Other FSC-certified veneers can be sourced. Many centro elements can have opaque color accents. Details and dimensions of all centro elements can adjusted to suit the interiors.

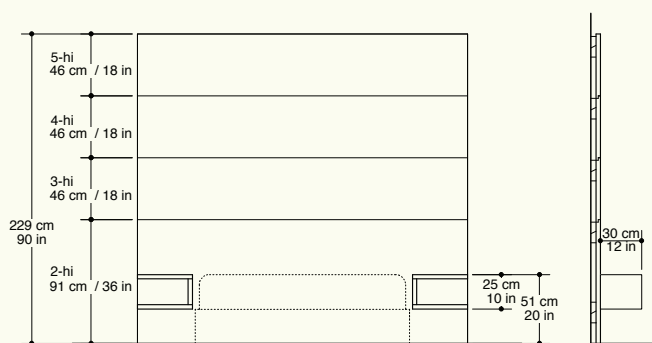
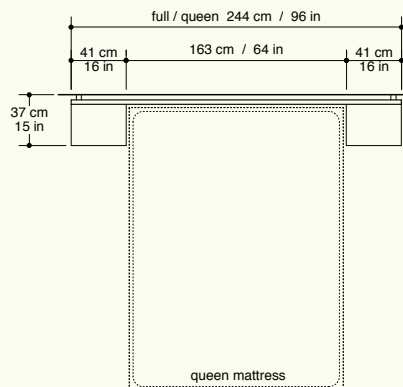

centro headboard | full/queen

2-hi | 3-hi | 4-hi | 5-hi stacking wall panels with cantilevered bedside tables

MATTRESS SIZES: full (54 x 75 in); queen (60 x 80 in)

SOLD SEPARATELY: centro platform base or Green Sleep foundation; Green Sleep mattress; pillows; bedding

MATERIALS + FINISHES: quarter sliced, slip matched veneer; 30° gloss level



Douglas Fir



Eucalyptus

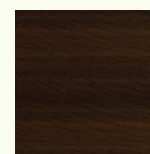

fumed White Oak

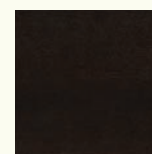

White Oak
stained dark cacao

p+a furniture aspires to set the standard for contract furnishings, with a simple and modern aesthetic and an inherent sustainability.

SCORECARD

MFG LOCATION: Calgary AB, regional if within 500 miles/800 km; veneers from Alberta (Douglas Fir), Germany (White Oak) and Portugal (Eucalyptus)

RECYCLED CONTENT: particleboard and medium density fiberboard (MDF) contain 100% post-industrial wood fiber

FSC CERTIFIED: veneers (SCS-COC-000947)

LOW EMITTING: no added urea formaldehyde; water-based finishes and stains, including durable UV-cured top coat

CARE: clean with a soft cloth dampened with a low VOC, quality wood furniture cleaner. Then dry with a clean microfiber polishing cloth. Wipe veneer in the direction of the grain.



WHITE OAK STAINED DARK CACAO, 5-HI QUEEN

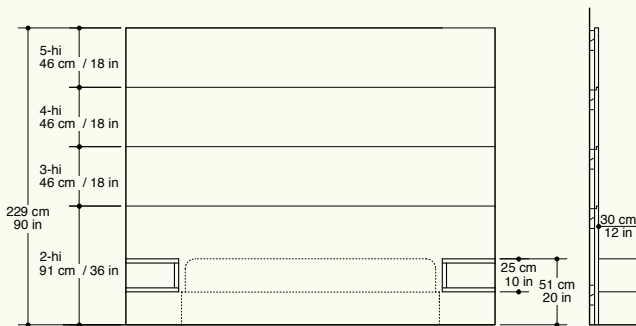
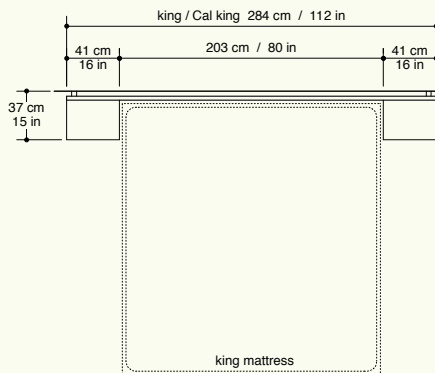

centro headboard | king

2-hi | 3-hi | 4-hi | 5-hi stacking wall panels with cantilevered bedside tables

MATTRESS SIZES: king (76 x 80 in); California king (72 x 84 in)

SOLD SEPARATELY: centro platform base or Green Sleep foundation; Green Sleep mattress; pillows; bedding

MATERIALS + FINISHES: quarter sliced, slip matched veneer; 30° gloss level

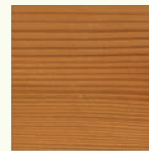

Douglas Fir



Eucalyptus

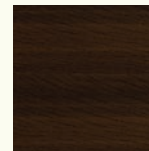

fumed White Oak

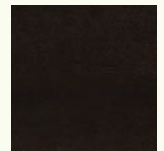

White Oak
stained dark cacao

p+a furniture aspires to set the standard for contract furnishings, with a simple and modern aesthetic and an inherent sustainability.

SCORECARD

MFG LOCATION: Calgary AB, regional if within 500 miles/800 km; veneers from Alberta (Douglas Fir), Germany (White Oak) and Portugal (Eucalyptus)

RECYCLED CONTENT: particleboard and medium density fiberboard (MDF) contain 100% post-industrial wood fiber

FSC CERTIFIED: veneers (SCS-COC-000947)

LOW EMITTING: no added urea formaldehyde; water-based finishes and stains, including durable UV-cured top coat

CARE: clean with a soft cloth dampened with a low VOC, quality wood furniture cleaner. Then dry with a clean microfiber polishing cloth. Wipe veneer in the direction of the grain.



EUCALYPTUS, 5-HI QUEEN

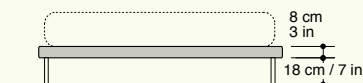
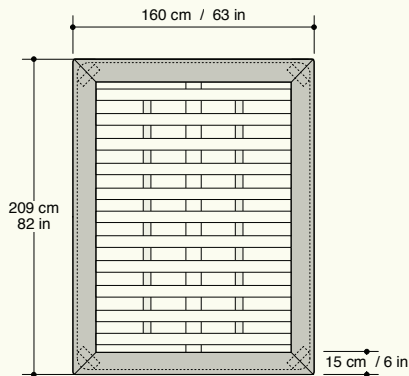

centro platform base for full/queen mattresses

FABRICS: Peyton available in 41 colors (38% polyester, 31% cotton, 21% viscose, 10% linen); Juneau available in 35 colors (92% polyester, 8% cotton)

ALSO AVAILABLE: solid Douglas Fir frame with a 30° gloss level water-based finish

MATTRESS SIZES: full (54 x 75 in); queen (60 x 80 in)

SOLD SEPARATELY: centro headboard; Green Sleep mattress; adjustable reading lights; pillows; bedding

MATERIALS: laminated exterior grade plywood frame wrapped with unbleached cotton batting and Dacron polyester, and upholstered with fabric; anodized aluminum L-angles and steel center rail support Maple slats; brushed nickel or polished chrome square or round legs, 7 or 10 in (17.8 or 25.4 cm) H

p+a furniture aspires to set the standard for contract furnishings, with a simple and modern aesthetic and an inherent sustainability.

SCORECARD

MFG LOCATION: Vancouver BC, regional if within 500 miles/800 km; legs manufactured in Los Angeles CA

RAPIDLY RENEWABLE: natural fibers

FSC CERTIFIED: if Douglas Fir (SCS-COC-000546)

LOW EMITTING: fabrics meet Oeko-Tex® Standard 100; no added urea formaldehyde; water-based finish if Douglas Fir

CARE: professionally clean. If solid Douglas Fir, clean with a soft cloth dampened with a low VOC, quality wood furniture cleaner. Then dry with a clean microfiber polishing cloth. Wipe veneer in the direction of the grain.



PEYTON #56 CHALK, QUEEN

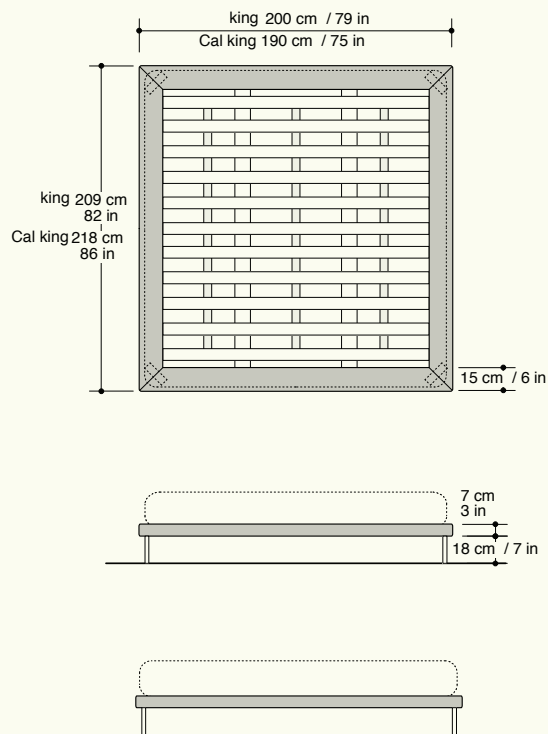

centro platform base for king/Cal king mattresses

FABRICS: Peyton available in 41 colors (38% polyester, 31% cotton, 21% viscose, 10% linen); Juneau available in 35 colors (92% polyester, 8% cotton)

ALSO AVAILABLE: solid Douglas Fir frame with a 30° gloss level water-based finish

MATTRESS SIZES: king (76 x 80 in); California king (72 x 84 in)

SOLD SEPARATELY: centro headboard; Green Sleep mattress; adjustable reading lights; pillows; bedding

MATERIALS: laminated exterior grade plywood frame wrapped with unbleached cotton batting and Dacron polyester, and upholstered with fabric; anodized aluminum L-angles and steel center rail support Maple slats; brushed nickel or polished chrome square or round legs, 7 or 10 in (17.8 or 25.4 cm) H

p+a furniture aspires to set the standard for contract furnishings, with a simple and modern aesthetic and an inherent sustainability.

SCORECARD

MFG LOCATION: Vancouver BC, regional if within 500 miles/800 km; legs manufactured in Los Angeles CA

RAPIDLY RENEWABLE: natural fibers

FSC CERTIFIED: if Douglas Fir (SCS-COC-000546)

LOW EMITTING: fabrics meet Oeko-Tex® Standard 100; no added urea formaldehyde; water-based finish if Douglas Fir

CARE: professionally clean. If solid Douglas Fir, clean with a soft cloth dampened with a low VOC, quality wood furniture cleaner. Then dry with a clean microfiber polishing cloth. Wipe veneer in the direction of the grain.



PEYTON #56 CHALK, QUEEN

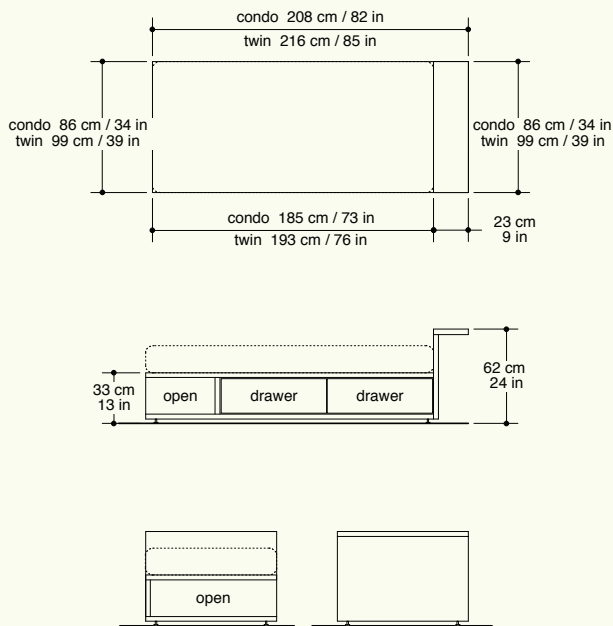

centro daybed base for condo futons/twin mattresses

with left or right side table and 2 soft close drawers with
integral finger pulls and open storage below

SOLD SEPARATELY: futon/mattress; bolster; covers; adjustable
table light with in-set pivot

MATERIALS + FINISHES: quarter sliced, slip matched veneer; 30°
gloss level

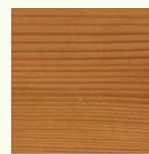

Douglas Fir



Eucalyptus

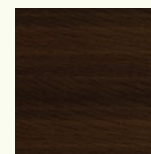

fumed White Oak

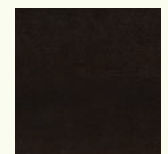

White Oak
stained dark cacao

p+a furniture aspires to set the standard for contract furnishings, with a simple and modern aesthetic and an inherent sustainability.

SCORECARD

MFG LOCATION: Calgary AB, regional if within 500 miles/800 km; veneers from Alberta (Douglas Fir), Germany (White Oak) and Portugal (Eucalyptus)

RECYCLED CONTENT: particleboard and medium density fiberboard (MDF) contain 100% post-industrial wood fiber

FSC CERTIFIED: veneers (SCS-COC-000947)

LOW EMITTING: no added urea formaldehyde; water-based finishes and stains, including durable UV-cured top coat

CARE: clean with a soft cloth dampened with a low VOC, quality wood furniture cleaner. Then dry with a clean microfiber polishing cloth. Wipe veneer in the direction of the grain.



FUMED WHITE OAK, RIGHT SIDE TABLE

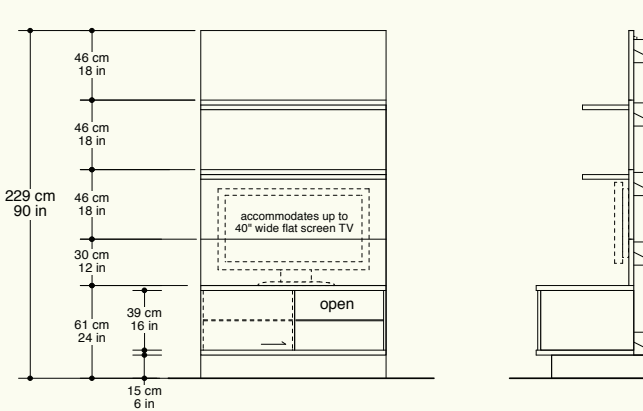
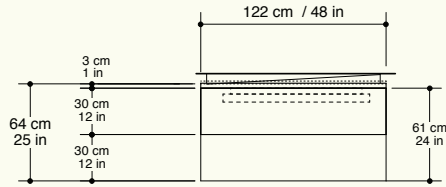

centro entertain

audio visual entertainment unit with sliding door and fixed and adjustable shelves

OPTIONS: matching veneer sliding door with adjustable tempered glass shelves; opaque color accents; concealed LED uplighting

MATERIALS + FINISHES: quarter sliced, slip matched veneer; 30° gloss level

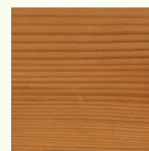

Douglas Fir



Eucalyptus

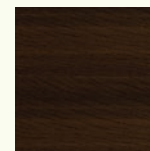

fumed White Oak

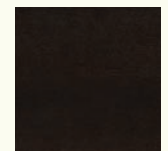

White Oak stained dark cacao

p+a furniture aspires to set the standard for contract furnishings, with a simple and modern aesthetic and an inherent sustainability.

SCORECARD

MFG LOCATION: Calgary AB, regional if within 500 miles/800 km; veneers from Alberta (Douglas Fir), Germany (White Oak) and Portugal (Eucalyptus)

RECYCLED CONTENT: particleboard and medium density fiberboard (MDF) contain 100% post-industrial wood fiber

FSC CERTIFIED: veneers (SCS-COC-000947)

LOW EMITTING: no added urea formaldehyde; water-based finishes and stains, including durable UV-cured top coat

CARE: clean with a soft cloth dampened with a low VOC, quality wood furniture cleaner. Then dry with a clean microfiber polishing cloth. Wipe veneer in the direction of the grain.



EUCALYPTUS WITH SNOW DOOR AND SHELVES

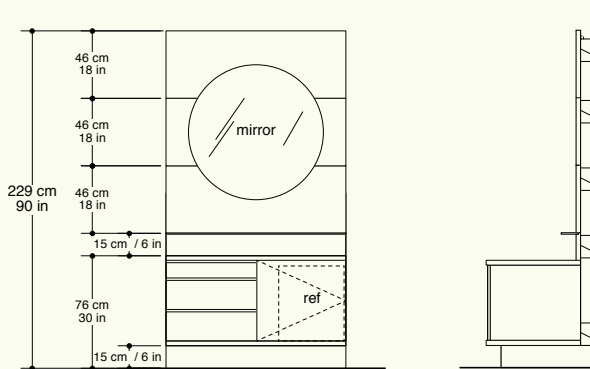
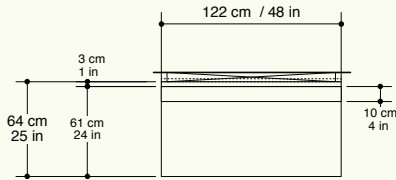

centro mini bar

with space to conceal refrigerator and soft-close snack drawers with integral finger pulls

OPTIONS: matching veneer doors; shallow tempered glass shelf; opaque color accents; concealed LED uplighting

MATERIALS + FINISHES: quarter sliced, slip matched veneer; 30° gloss level

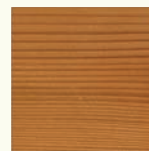

Douglas Fir



Eucalyptus

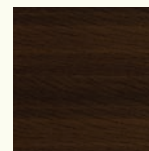

fumed White Oak

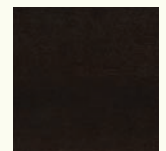

White Oak
stained dark cacao

p+a furniture aspires to set the standard for contract furnishings, with a simple and modern aesthetic and an inherent sustainability.

SCORECARD

MFG LOCATION: Calgary AB, regional if within 500 miles/800 km; veneers from Alberta (Douglas Fir), Germany (White Oak) and Portugal (Eucalyptus)

RECYCLED CONTENT: particleboard and medium density fiberboard (MDF) contain 100% post-industrial wood fiber

FSC CERTIFIED: veneers (SCS-COC-000947)

LOW EMITTING: no added urea formaldehyde; water-based finishes and stains, including durable UV-cured top coat

CARE: clean with a soft cloth dampened with a low VOC, quality wood furniture cleaner. Then dry with a clean microfiber polishing cloth. Wipe veneer in the direction of the grain.



EUCALYPTUS WITH SNOW DOOR AND GLASS SHELF

p+a furniture

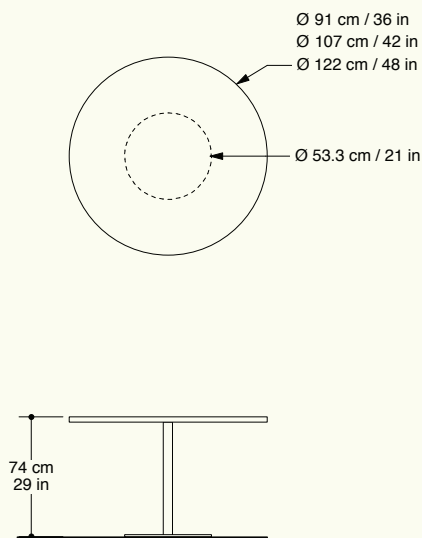

centro dine

1 1/4 in (3.2 cm) thick round table top with veneer edge and disc base

MATERIALS + FINISHES: quarter sliced, slip matched veneer; 30° gloss level; brushed nickel or polished chrome disc base

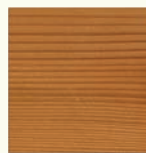

Douglas Fir

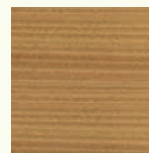

Eucalyptus

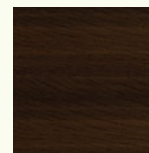

fumed White Oak

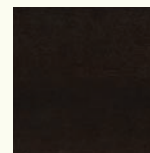

White Oak
stained dark cacao

p+a furniture aspires to set the standard for contract furnishings, with a simple and modern aesthetic and an inherent sustainability.

SCORECARD

MFG LOCATION: Calgary AB, regional if within 500 miles/800 km; veneers from Alberta (Douglas Fir), Germany (White Oak) and Portugal (Eucalyptus); bases manufactured in Mississauga ON

RECYCLED CONTENT: particleboard and medium density fiberboard (MDF) contain 100% post-industrial wood fiber

FSC CERTIFIED: veneers (SCS-COC-000947)

LOW EMITTING: no added urea formaldehyde; water-based finishes and stains, including durable UV-cured top coat

CARE: clean with a soft cloth dampened with a low VOC, quality wood furniture cleaner. Then dry with a clean microfiber polishing cloth. Wipe veneer in the direction of the grain.



FUMED WHITE OAK

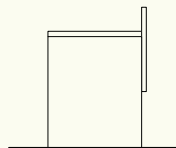
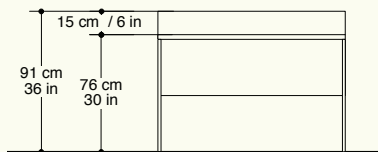
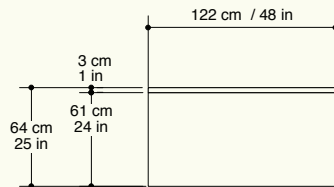

centro work I

freestanding desk with modesty panel

OPTIONS: opaque color accents

MATERIALS + FINISHES: quarter sliced, slip matched veneer; 30° gloss level

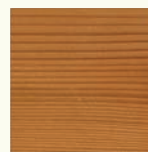

Douglas Fir



Eucalyptus

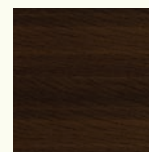

fumed White Oak

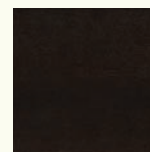

White Oak
stained dark cacao

p+a furniture aspires to set the standard for contract furnishings, with a simple and modern aesthetic and an inherent sustainability.

SCORECARD

MFG LOCATION: Calgary AB, regional if within 500 miles/800 km; veneers from Alberta (Douglas Fir), Germany (White Oak) and Portugal (Eucalyptus)

RECYCLED CONTENT: particleboard and medium density fiberboard (MDF) contain 100% post-industrial wood fiber

FSC CERTIFIED: veneers (SCS-COC-000947)

LOW EMITTING: no added urea formaldehyde; water-based finishes and stains, including durable UV-cured top coat

CARE: clean with a soft cloth dampened with a low VOC, quality wood furniture cleaner. Then dry with a clean microfiber polishing cloth. Wipe veneer in the direction of the grain.



EUCALYPTUS

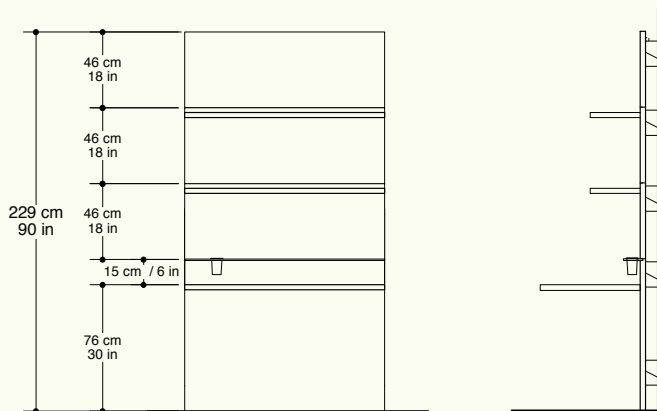
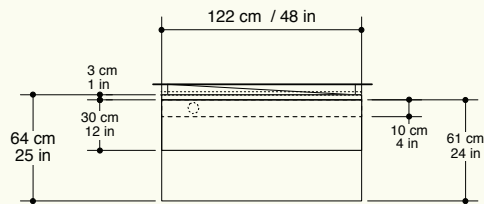

centro work II

cantilevered desk with fixed shelves

OPTIONS: shallow tempered glass shelf with pencil holder; opaque color accents; concealed LED uplighting

MATERIALS + FINISHES: quarter sliced, slip matched veneer; 30° gloss level

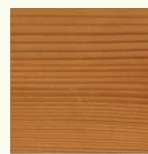

Douglas Fir



Eucalyptus

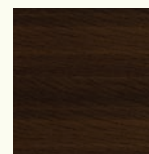

fumed White Oak

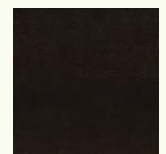

White Oak
stained dark cacao

p+a furniture aspires to set the standard for contract furnishings, with a simple and modern aesthetic and an inherent sustainability.

SCORECARD

MFG LOCATION: Calgary AB, regional if within 500 miles/800 km; veneers from Alberta (Douglas Fir), Germany (White Oak) and Portugal (Eucalyptus)

RECYCLED CONTENT: particleboard and medium density fiberboard (MDF) contain 100% post-industrial wood fiber

FSC CERTIFIED: veneers (SCS-COC-000947)

LOW EMITTING: no added urea formaldehyde; water-based finishes and stains, including durable UV-cured top coat

CARE: clean with a soft cloth dampened with a low VOC, quality wood furniture cleaner. Then dry with a clean microfiber polishing cloth. Wipe veneer in the direction of the grain.



EUCALYPTUS WITH SNOW AND GLASS SHELVES

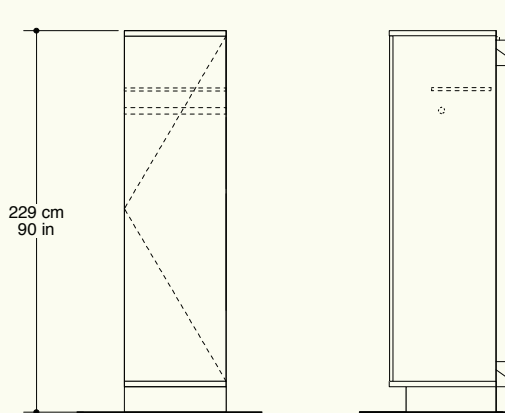
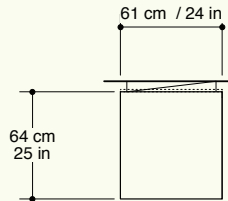

centro storage I

with hinged door, fixed shelf and clothing rod

OPTIONS: door hinged left or right; opaque color accents
concealed LED uplighting

MATERIALS + FINISHES: quarter sliced, slip matched veneer; 30°
gloss level

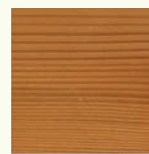

Douglas Fir



Eucalyptus

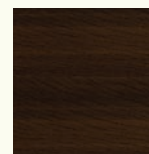

fumed White Oak

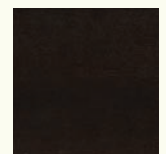

White Oak
stained dark cacao

p+a furniture aspires to set the standard for contract furnishings, with a simple and modern aesthetic and an inherent sustainability.

SCORECARD

MFG LOCATION: Calgary AB, regional if within 500 miles/800 km; veneers from Alberta (Douglas Fir), Germany (White Oak) and Portugal (Eucalyptus)

RECYCLED CONTENT: particleboard and medium density fiberboard (MDF) contain 100% post-industrial wood fiber

FSC CERTIFIED: veneers (SCS-COC-000947)

LOW EMITTING: no added urea formaldehyde; water-based finishes and stains, including durable UV-cured top coat

CARE: clean with a soft cloth dampened with a low VOC, quality wood furniture cleaner. Then dry with a clean microfiber polishing cloth. Wipe veneer in the direction of the grain.



EUCALYPTUS WITH SNOW INTERIOR SHELF

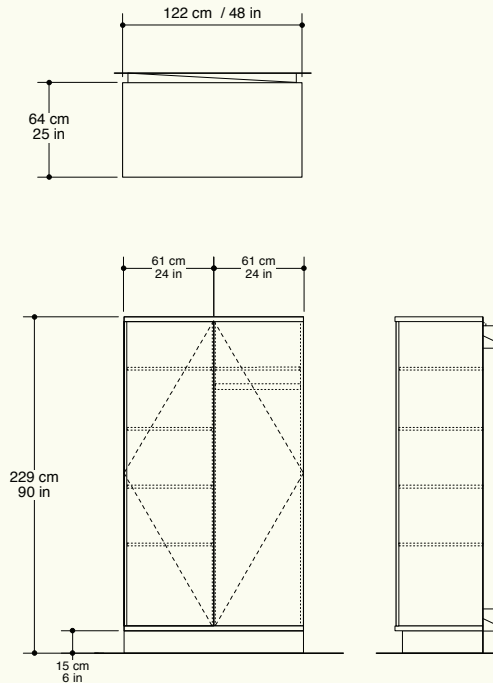

centro storage II

with adjustable shelves and clothing rod

OPTIONS: opaque color accents; concealed LED uplighting

MATERIALS + FINISHES: quarter sliced, slip matched veneer; 30° gloss level

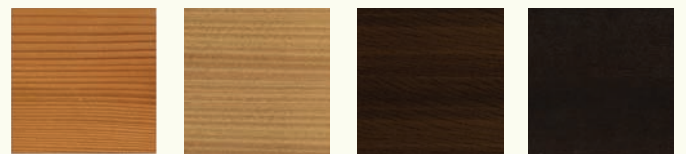

Douglas Fir

Eucalyptus

fumed White Oak

White Oak
stained dark cacao

p+a furniture aspires to set the standard for contract furnishings, with a simple and modern aesthetic and an inherent sustainability.

SCORECARD

MFG LOCATION: Calgary AB, regional if within 500 miles/800 km; veneers from Alberta (Douglas Fir), Germany (White Oak) and Portugal (Eucalyptus)

RECYCLED CONTENT: particleboard and medium density fiberboard (MDF) contain 100% post-industrial wood fiber

FSC CERTIFIED: veneers (SCS-COC-000947)

LOW EMITTING: no added urea formaldehyde; water-based finishes and stains, including durable UV-cured top coat

CARE: clean with a soft cloth dampened with a low VOC, quality wood furniture cleaner. Then dry with a clean microfiber polishing cloth. Wipe veneer in the direction of the grain.



EUCALYPTUS WITH SNOW INTERIOR SHELVES

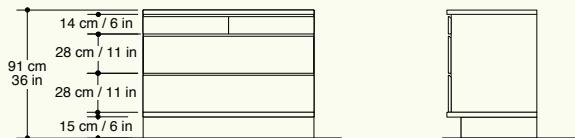
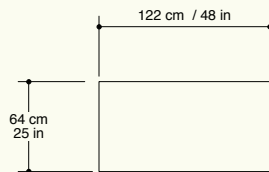

centro storage III

with 4 soft close drawers and integral finger pulls

OPTIONS: opaque color accents

MATERIALS + FINISHES: quarter sliced, slip matched veneer; 30° gloss level

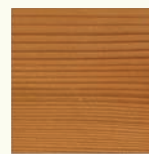

Douglas Fir

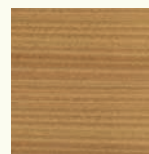

Eucalyptus

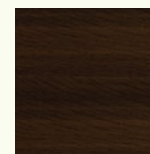

fumed White Oak

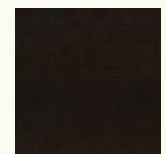

White Oak
stained dark cacao

p+a furniture aspires to set the standard for contract furnishings, with a simple and modern aesthetic and an inherent sustainability.

SCORECARD

MFG LOCATION: Calgary AB, regional if within 500 miles/800 km; veneers from Alberta (Douglas Fir), Germany (White Oak) and Portugal (Eucalyptus)

RECYCLED CONTENT: particleboard and medium density fiberboard (MDF) contain 100% post-industrial wood fiber

FSC CERTIFIED: veneers (SCS-COC-000947)

LOW EMITTING: no added urea formaldehyde; water-based finishes and stains, including durable UV-cured top coat

CARE: clean with a soft cloth dampened with a low VOC, quality wood furniture cleaner. Then dry with a clean microfiber polishing cloth. Wipe veneer in the direction of the grain.



EUCALYPTUS WITH SNOW DRAWERS

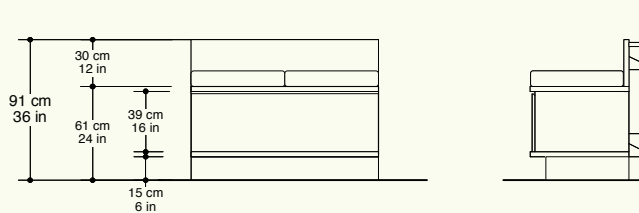
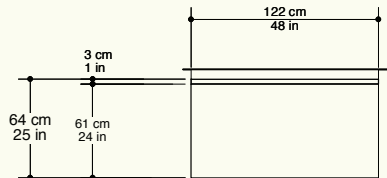

centro bench I

OPTIONS: seat cushions; soft close storage drawer with integral finger pull

MATERIALS + FINISHES: quarter sliced, slip matched veneer; 30° gloss level

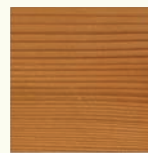

Douglas Fir

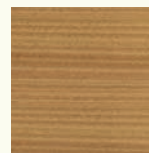

Eucalyptus

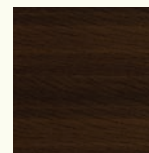

fumed White Oak

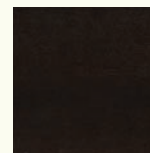

White Oak
stained dark cacao

p+a furniture aspires to set the standard for contract furnishings, with a simple and modern aesthetic and an inherent sustainability.

SCORECARD

MFG LOCATION: Calgary AB, regional if within 500 miles/800 km; veneers from Alberta (Douglas Fir), Germany (White Oak) and Portugal (Eucalyptus)

RECYCLED CONTENT: particleboard and medium density fiberboard (MDF) contain 100% post-industrial wood fiber

FSC CERTIFIED: veneers (SCS-COC-000947)

LOW EMITTING: no added urea formaldehyde; water-based finishes and stains, including durable UV-cured top coat

CARE: clean with a soft cloth dampened with a low VOC, quality wood furniture cleaner. Then dry with a clean microfiber polishing cloth. Wipe veneer in the direction of the grain.



EUCALYPTUS WITH DRAWER

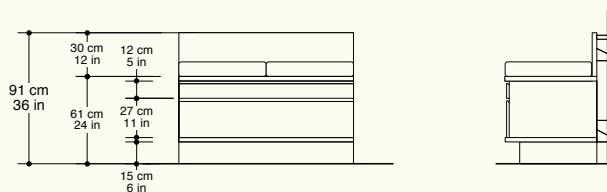
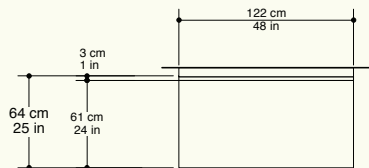

centro bench II

with 2 soft close drawers and integral finger pulls

OPTIONS: seat cushions

MATERIALS + FINISHES: quarter sliced, slip matched veneer; 30° gloss level



Douglas Fir



Eucalyptus

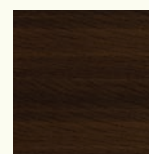

fumed White Oak

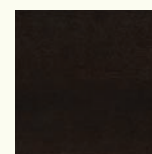

White Oak
stained dark cacao

p+a furniture aspires to set the standard for contract furnishings, with a simple and modern aesthetic and an inherent sustainability.

SCORECARD

MFG LOCATION: Calgary AB, regional if within 500 miles/800 km; veneers from Alberta (Douglas Fir), Germany (White Oak) and Portugal (Eucalyptus)

RECYCLED CONTENT: particleboard and medium density fiberboard (MDF) contain 100% post-industrial wood fiber

FSC CERTIFIED: veneers (SCS-COC-000947)

LOW EMITTING: no added urea formaldehyde; water-based finishes and stains, including durable UV-cured top coat

CARE: clean with a soft cloth dampened with a low VOC, quality wood furniture cleaner. Then dry with a clean microfiber polishing cloth. Wipe veneer in the direction of the grain.



EUCALYPTUS WITH DRAWERS

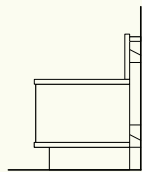
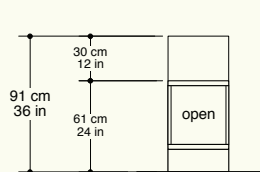
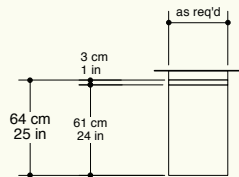

centro bench III

OPTIONS: adjustable tempered glass shelf

MATERIALS + FINISHES: quarter sliced, slip matched veneer; 30° gloss level

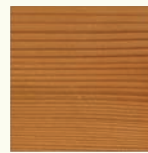

Douglas Fir



Eucalyptus

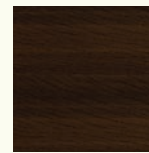

fumed White Oak

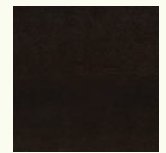

White Oak
stained dark cacao

p+a furniture aspires to set the standard for contract furnishings, with a simple and modern aesthetic and an inherent sustainability.

SCORECARD

MFG LOCATION: Calgary AB, regional if within 500 miles/800 km; veneers from Alberta (Douglas Fir), Germany (White Oak) and Portugal (Eucalyptus)

RECYCLED CONTENT: particleboard and medium density fiberboard (MDF) contain 100% post-industrial wood fiber

FSC CERTIFIED: veneers (SCS-COC-000947)

LOW EMITTING: no added urea formaldehyde; water-based finishes and stains, including durable UV-cured top coat

CARE: clean with a soft cloth dampened with a low VOC, quality wood furniture cleaner. Then dry with a clean microfiber polishing cloth. Wipe veneer in the direction of the grain.



EUCALYPTUS

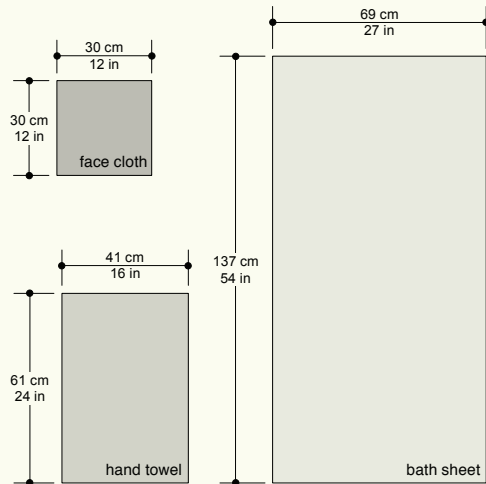

organic cotton terry towels

COLOR: snow

SIZES: face cloths, hand towels and bath sheets

ALSO AVAILABLE: bath mats and bathrobes

MATERIALS: naturally dyed 100% certified organic cotton terry towels

p+a furniture aspires to set the standard for contract furnishings, with a simple and modern aesthetic and an inherent sustainability.

SCORECARD

MFG LOCATION: India

RAPIDLY RENEWABLE: organic cotton

CERTIFIED ORGANIC: GOTS/EKO Sustainable Textile
C803199GOTS-01.2008

CARE: machine wash with like-colors in hot water at 130°F (54°C) or above. Tumble dry.



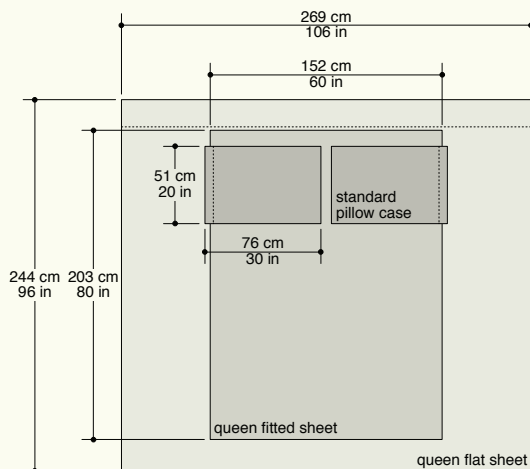

organic cotton Sateen sheet sets

COLORS: natural and white

SIZES: twin, full, queen, king and California king; standard and king pillow cases; 15 in (38.1 cm) deep fitted sheet

MATERIALS: 250 TC (thread count) 100% certified organic cotton Sateen flat and fitted sheets with pillow case(s)

p+a furniture aspires to set the standard for contract furnishings, with a simple and modern aesthetic and an inherent sustainability.

SCORECARD

MFG LOCATION: India

RAPIDLY RENEWABLE: organic cotton

CERTIFIED ORGANIC: GOTS/EKO Sustainable Textile
C804033GOTS-02.2008

CARE: machine wash with like-colors in hot water at 130°F (54°C) or above. Tumble dry. Expect up to 5% shrinkage after initial wash and dry.



WHITE

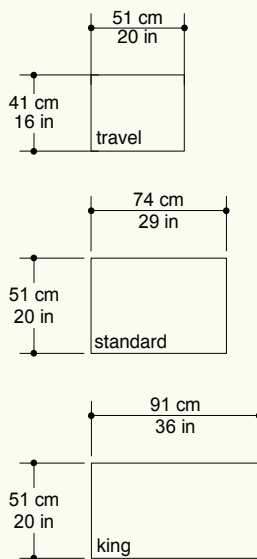

Crescent Moon alpaca + sheep wool pillows

SIZES: travel, standard and king

OPTIONS: medium and firm fill

ALSO AVAILABLE: duvets; mattress and pillow encasements; mattress pads

MATERIALS: natural alpaca (70%) and sheep (30%) wool pillow with 260 TC (thread count) certified organic cotton cover

p+a furniture aspires to set the standard for contract furnishings, with a simple and modern aesthetic and an inherent sustainability.

SCORECARD

MFG LOCATION: Kelowna BC, regional if within 500 miles/800 km

RAPIDLY RENEWABLE: alpaca and sheep wool, organic cotton

CERTIFIED ORGANIC: GOTS C811099GOTS-01.2008 (cover)

CARE: refer label on pillow and download Crescent Moon care and cleaning instructions (pdf) at pafurniture.ca/downloads.php



STANDARD/QUEEN

WARRANTY

p+a furniture casegoods are warranted to be free from defects in material and workmanship for 5 years. During this period, p+a will repair or at its discretion, replace, free of charge, any defective item(s). Handling and shipping costs are the responsibility of the purchaser.

Warranty does not include damage resulting from conditions outside of the control of p+a furniture including, but not limited to, accidents, misuse, negligence and any unspecified alterations. p+a furniture is not warranted against fading, wear or marking.

This warranty is void against any and all damage caused by partial and or full installation by those not affiliated with p+a furniture.

warranty

P+A VENDORS' WARRANTIES

Other merchandise is subject to individual vendors' warranties. All other warranties in conjunction to p+a furniture merchandise whether by law, implied or expressed are hereby excluded.

p + a
FURNITURE

P+A FURNITURE INC
VANCOUVER CANADA
PAFURNITURE.CA

STORE@PAFURNITURE.CA
1 877 255 2029
604 255 2089